



PDA36A(-EC) Si Switchable Gain Detector

User Guide



















Table of Contents

Chapter 1	Warning Symbol Definitions	2
Chapter 2	Description	3
Chapter 3	Setup	3
Chapter 4	Operation	4
4.1.	<i>Theory of Operation</i>	4
4.2.	<i>Responsivity</i>	5
4.3.	<i>Dark Current</i>	5
4.4.	<i>Bandwidth and Response</i>	5
4.5.	<i>Terminating Resistance</i>	6
4.6.	<i>Gain Adjustment</i>	6
Chapter 5	Troubleshooting.....	7
Chapter 6	Specifications.....	8
6.1.	<i>Response Curve</i>	10
6.2.	<i>Mechanical Drawing</i>	11
Chapter 7	Certificate of Conformance.....	12
Chapter 8	Regulatory	13
Chapter 9	Thorlabs Worldwide Contacts	14

Chapter 1 Warning Symbol Definitions

Below is a list of warning symbols you may encounter in this manual or on your device.

Symbol	Description
	Direct Current
	Alternating Current
	Both Direct and Alternating Current
	Earth Ground Terminal
	Protective Conductor Terminal
	Frame or chassis Terminal
	Equipotentiality
	On (Supply)
	Off (Supply)
	In Position of a Bi-Stable Push Control
	Out Position of a Bi-Stable Push Control
	Caution, Risk of Electric Shock
	Caution, Hot Surface
	Caution, Risk of Danger
	Warning, Laser Radiation
	Caution, Spinning Blades May Cause Harm

Chapter 2 Description

The PDA36A is an amplified, switchable-gain, silicon detector designed for detection of light signals over 350 to 1100 nm wavelength range. An eight-position rotary switch allows the user to vary the gain in 10 dB steps. A buffered output drives 50 Ω load impedances up to 5 V. The PDA36A housing includes a removable threaded coupler (SM1T1) and retainer ring (SM1RR) that is compatible with any number of Thorlabs 1" threaded accessories. This allows convenient mounting of external optics, light filters, apertures, as well as providing an easy mounting mechanism using the Thorlabs cage assembly accessories.

Chapter 3 Setup

The detector can be set up in many different ways using our extensive line of adapters. However, the detector should always be mounted and secured for best operation.

1. Unpack the optical head, install a Thorlabs TR-series 1/2" diameter post into one of the #8-32 (M4 on -EC version) tapped holes, located on the bottom and side of the head, and mount into a PH-series post holder.
2. Connect the power supply 3-pin plug into the power receptacle on the PDA36A.
3. Plug the power supply into a 50 to 60Hz, 100 to 120 VAC outlet (220 to 240 VAC for -EC version).
4. Attach a 50 Ω coax cable (i.e. RG-58U) to the output of the PDA. When running cable lengths longer than 12" we recommend terminating the opposite end of the coax with a 50 Ω resistor (Thorlabs p/n T4119) for maximum performance. Connect the remaining end to a measurement device such as an oscilloscope or high speed DAQ card. Caution: Many high speed oscilloscopes have input impedances of 50 Ω . In this case, do not install a 50 Ω terminator. The combined loads will equal 25 Ω which could allow ~135 mA of output current. This will damage the output driver of the PDA36A.
5. Power the PDA36A on using the power switch located on the top side of the unit.



Caution!



The PDA36A was designed to allow maximum accessibility to the photodetector by having the front surface of the diode flush with the outside of the PDA housing. When using fiber adapters, make sure that the fiber ferrule does not crash into the detector. Failure to do so may cause damage to the diode and/or the fiber. An easy way to accomplish this is to install a SM1RR retaining ring (included with the PDA36A) inside the 1" threaded coupler before installing the fiber adapter.

6. Install any desired filters, optics, adapters, or fiber adapters to the input aperture. Caution: The PDA36A was designed to allow maximum accessibility to the photodetector by having the front surface of the diode flush with the outside of the PDA housing. When using fiber adapters, make sure that the fiber ferrule does not crash into the detector. Failure to do so may cause damage to the diode and/or the fiber. An easy way to accomplish this is to install a SM1RR retaining ring (included with the PDA36A) inside the 1" threaded coupler before installing the fiber adapter.
7. Apply a light source to the detector. Adjust the gain to the desired setting.

Chapter 4 Operation

4.1. Theory of Operation

Thorlabs PDA series are ideal for measuring both pulsed and CW light sources. The PDA36A includes a reverse-biased PIN photo diode, mated to a switchable gain transimpedance amplifier, and packaged in a rugged housing.

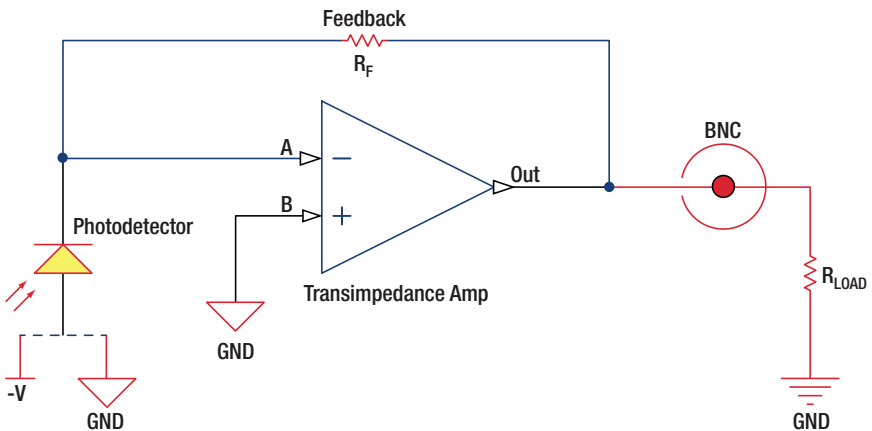

4.2. Responsivity

The responsivity of a photodiode can be defined as a ratio of generated photocurrent (I_{PD}) to the incident light power (P) at a given wavelength:

$$R(\lambda) = \frac{I_{PD}}{P}$$

4.3. Dark Current

Dark current is leakage current which flows when a bias voltage is applied to a photodiode. The PDA with Transimpedance Amplifier does control the dark current flowing out. Looking at the figure above, it can be noted that Point B is held at ground and the amplifier will try to hold point A to “Virtual Ground”. This minimizes the effects of dark current present in the system.

The dark current present is also affected by the photodiode material and the size of the active area. Silicon devices generally produce low dark current compared to germanium devices which have high dark currents. The table below lists several photodiode materials and their relative dark currents, speeds, sensitivity, and costs.

Material	Dark Current	Speed	Sensitivity ¹ (nm)	Cost
Silicon (Si)	Low	High	400 – 1000	Low
Germanium (Ge)	High	Low	900 – 1600	Low
Gallium Phosphide (GaP)	Low	High	150 – 550	Med
Indium Gallium Arsenide (InGaAs)	Low	High	800 – 1800	Med
Extended Range: Indium Gallium Arsenide (InGaAs)	High	High	1200 – 2600	High

4.4. Bandwidth and Response

A load resistor will react with the photodetector junction capacitance to limit the bandwidth. For best frequency response, a 50 Ω terminator should be used in conjunction with a 50 Ω coaxial cable. The gain of the detector is dependent on the feedback element (R_f). The bandwidth of the detector can be calculated using the following:

$$f(-3dB) = \sqrt{\frac{GBP}{4\pi R_f \times C_D}}$$

Where GBP is the amplifier gain bandwidth product and C_D is the sum of the photodiode junction capacitance and the amplifier capacitance.

¹ Approximate values, actual wavelength values will vary from unit to unit

4.5. Terminating Resistance

A load resistance is used to convert the generated photocurrent into a voltage (V_{OUT}) for viewing on an oscilloscope:

Depending on the type of the photodiode, load resistance can affect the response speed. For maximum bandwidth, we recommend using a 50 Ω coaxial cable with a 50 Ω terminating resistor at the opposite end of the cable. This will minimize ringing by matching the cable with its characteristic impedance. If bandwidth is not important, you may increase the amount of voltage for a given light level by increasing R_{LOAD} . In an unmatched termination the length of the coaxial cable can have a profound impact on the response, so it is recommended to keep the cable as short as possible.

The maximum output of the PDA36A is 10 volts for high impedance loads (i.e. $R_{Load} > 5 \text{ k}\Omega$) and 5 volts for 50 Ω loads. Adjust the gain so that the measured signal level out of the PDA36A is below 10 volts (5 volts with a 50 Ω load) to avoid saturation.

For low terminating resistors, $<5 \text{ k}\Omega$ or 1% error, an additional factor needs to be considered. As described above the output includes a 50 Ω series resistor (R_S). The output load creates a voltage divider with the 50 Ω series resistor as follows:

$$Scale\ Factor = \frac{R_{Load}}{R_{Load} + R_S}$$

$$V_{OUT} = \mathcal{R}(\lambda) * Transimpedance\ Gain * Scale\ Factor * Input\ Power\ (W)$$

4.6. Gain Adjustment

The PDA36A includes a low noise, low offset, high gain transimpedance amplifier that allows gain adjustment over a 70dB range. The gain is adjusted by rotating the gain control knob, located on the top side of the unit. There are 8 gain positions incremented in 10dB steps. It is important to note that the bandwidth will decrease as the gain increases. See the specifications table in **Chapter 6** to choose the best gain vs. bandwidth for a given input signal.

Chapter 5 Troubleshooting

Problem	Suggested Solutions
There is no signal response.	Verify that the power is switched on and all connections are secure.
	Verify the proper terminating resistor is installed if using a Voltage measurement device.
	Verify that the optical signal wavelength is within the specified wavelength range.
	Verify that the optical signal is illuminating the detector active area.
Output Voltage will not increase. Detector Output is skewed.	Check to make sure the detector is not saturated. Refer to the Output Voltage spec. in the Specifications table. Install a 1" Lens Tube (SM1L10) to the thread coupler (SM1T1) to baffle any external light sources to see if this improves the response.

Chapter 6 Specifications

Performance Specifications ^{2,3}			
0 dB Setting		40 dB Setting	
Gain (Hi-Z)	1.51×10^3 V/A $\pm 2\%$	Gain (Hi-Z)	1.51×10^5 V/A $\pm 2\%$
Gain (50 Ω)	0.75×10^3 V/A $\pm 2\%$	Gain (50 Ω)	0.75×10^5 V/A $\pm 2\%$
Bandwidth	10.0 MHz	Bandwidth	150 kHz
Noise (RMS)	300 μ V	Noise (RMS)	340 μ V
NEP (@ λ_p)	2.91×10^{-11} W/ $\sqrt{\text{Hz}}$	NEP (@ λ_p)	5.93×10^{-13} W/ $\sqrt{\text{Hz}}$
Offset	3 mV (10 mV max)	Offset	4 mV (10 mV max)
10 dB Setting		50 dB Setting	
Gain (Hi-Z)	4.75×10^3 V/A $\pm 2\%$	Gain (Hi-Z)	4.75×10^5 V/A $\pm 2\%$
Gain (50 Ω)	2.38×10^3 V/A $\pm 2\%$	Gain (50 Ω)	2.38×10^5 V/A $\pm 2\%$
Bandwidth	5.5 MHz	Bandwidth	45 kHz
Noise (RMS)	280 μ V	Noise (RMS)	400 μ V
NEP (@ λ_p)	7.52×10^{-12} W/ $\sqrt{\text{Hz}}$	NEP (@ λ_p)	7.94×10^{-13} W/ $\sqrt{\text{Hz}}$
Offset	4 mV (10 mV max)	Offset	4 mV (10 mV max)
20 dB Setting		60 dB Setting	
Gain (Hi-Z)	1.5×10^4 V/A $\pm 2\%$	Gain (Hi-Z)	1.5×10^6 V/A $\pm 5\%$
Gain (50 Ω)	0.75×10^4 V/A $\pm 2\%$	Gain (50 Ω)	0.75×10^6 V/A $\pm 5\%$
Bandwidth	1.0 MHz	Bandwidth	11 kHz
Noise (RMS)	250 μ V	Noise (RMS)	800 μ V
NEP (@ λ_p)	2.34×10^{-12} W/ $\sqrt{\text{Hz}}$	NEP (@ λ_p)	1.43×10^{-12} W/ $\sqrt{\text{Hz}}$
Offset	4 mV (10 mV max)	Offset:	5 mV (10 mV max)
30 dB Setting		70 dB Setting	
Gain (Hi-Z)	4.75×10^4 V/A $\pm 2\%$	Gain (Hi-Z)	4.75×10^6 V/A $\pm 5\%$
Gain (50 Ω)	2.38×10^4 V/A $\pm 2\%$	Gain (50 Ω)	2.38×10^6 V/A $\pm 5\%$
Bandwidth	260 kHz	Bandwidth	5 kHz
Noise (RMS)	260 μ V	Noise (RMS)	1.10 mV
NEP (@ λ_p)	1.21×10^{-12} W/ $\sqrt{\text{Hz}}$	NEP (@ λ_p)	2.10×10^{-12} W/ $\sqrt{\text{Hz}}$
Offset	4 mV (10 mV max)	Offset	6 mV (10 mV max)

² All measurements performed with a 50 Ω load unless stated otherwise.

³ The PDA36A has a 50 Ω series terminator resistor (i.e. in series with amplifier output). This forms a voltage divider with any load impedance (e.g. 50 Ω load divides signal in half).

Electrical Specifications		
Detector		Si PIN
Active Area		3.6 x 3.6 mm (13 mm ²)
Wavelength Range	λ	350 to 1100 nm
Peak Wavelength	λ_p	970 nm (Typ)
Peak Response	$\Re(\lambda_p)$	0.65 A/W (Typ)
Amplifier GBP		600 MHz
Output Impedance		50 Ω
Max Output Current	I_{OUT}	100 mA
Load Impedance		50 Ω to Hi-Z
Gain Adjustment Range		0 dB to 70 dB
Gain Steps		8 x 10dB Steps
Output Voltage	V_{OUT}	0 to 5 V (50 Ω) 0 to 10 V (Hi-Z)
General		
On/Off Switch		Slide
Gain Switch		8 Position Rotary
Output		BNC (DC Coupled)
Package Size		2.76" x 2.06" x 0.88" (70.1 mm x 52.3 mm x 22.4 mm)
PD Surface Depth		0.16" (4.1 mm)
Weight, Detector Only		0.15 lbs
Accessories		SM1T1 Coupler SM1RR Retainer Ring
Operating Temp		0 to 40 °C
Storage Temp		-55 to 125 °C
AC Power Supply		AC – DC Converter
Input Power ⁴		31 W 100 – 200 VAC (50 to 60Hz) 220 – 240 VAC (50 to 60 Hz)

⁴ Although the power supply is rated for 31 W the PDA36A actual usage is <5 W over the full operating range.

6.1. Response Curve

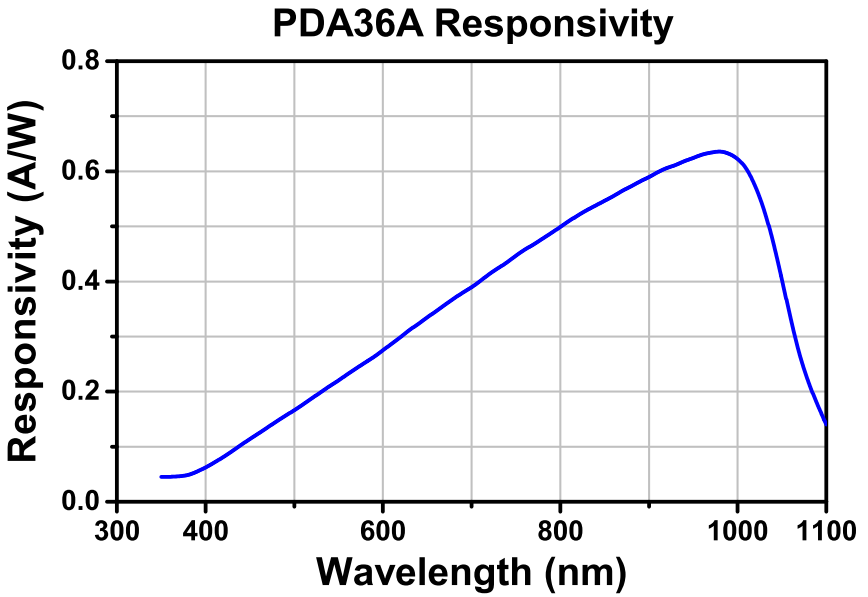

6.2. Mechanical Drawing

Visit the web for a more detailed mechanical drawing.

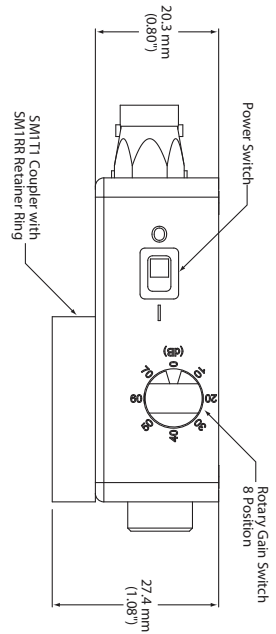
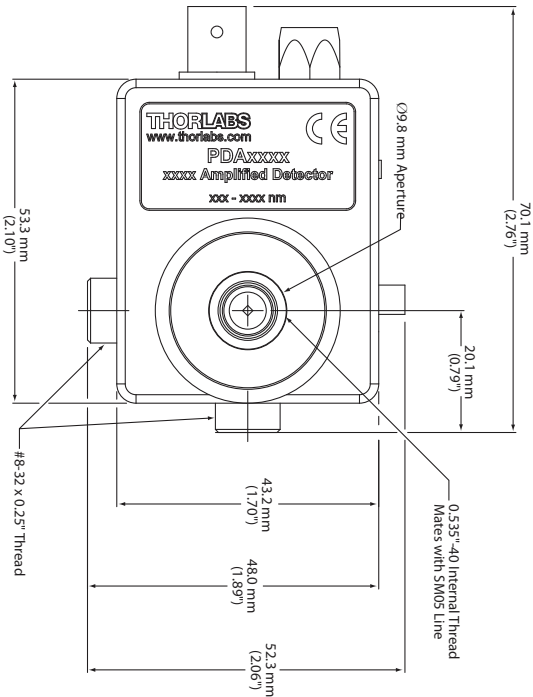
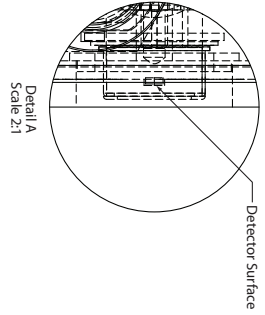
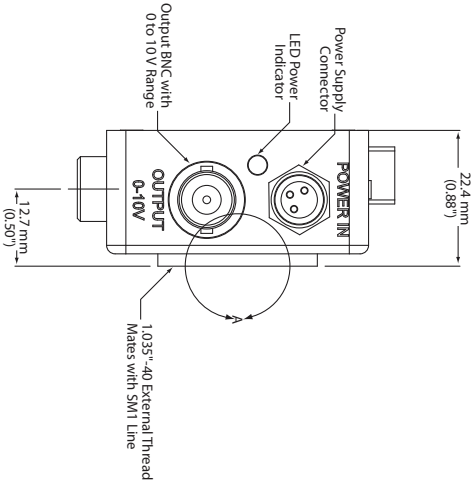

Chapter 7 Certificate of Conformance

Konformitätserklärung Declaration of Conformity Déclaration de Conformité

Thorlabs Inc
56 Sparta Ave.
Newton, NJ
USA

erklärt in alleiniger Verantwortung, dass das Produkt:
declares under it's own responsibility, that the product:
déclare sous notre seule responsabilité, que le produit:

PDA10A, PDA8A, PDF10A, PDA36A, PDA100A, PDA8A/M, PDF10A/M, PDA36A-EC, PDA10AEC, PDA100A-EC, PDA10CF, PDA10CS, PDF10C, PDA10D, PDA10CF-EC, PDA10CS-EC, PDF10C/M, PDA10D-EC, PDA50B, PDA50B-EC, PDA30G, PDA20H, PDA30G-EC, PDA20H-EC, PDA25K, PDA25K-EC, DET25K, DET25K/M, DET10A, DET36A, DET100A, DET100A/M, DET10A/M, DET36A/M, DET50B, DET50B/M, DET20C, DET20C/M, DET30B, DET30B/M, PDA30B, PDA30B-EC, DET10D, DET10D/M, PDA20C, PDA20C/M, PDA20CS, PDA20CS-EC, DET01CFC, DET01CFC/M, DET02AFC, DET02AFC/M

mit den Anforderungen der Normen
fulfills the requirements of the standard
satisfait aux exigences des normes

2006/95 EC
EMC 2004/108/EC
EN 61010-1:2001
EN 61326-1:2006
CISPR 11 Edition 4:2003
CISPR 11 Edition 4:2003
IEC 61000-3-2,
IEC 61000-3-3
IEC 61000-4-2
IEC 61000-4-3
IEC 61000-4-4
IEC 61000-4-4
IEC 61000-4-5
IEC 61000-4-6
IEC 61000-4-6
IEC 61000-4-11

Low Voltage Directive 12.Dec. 2006
Electromagnetic Compatibility Directive
Safety of Test and Measurement Equipment
EMC of Test and Measurement Equipment
Conducted Emissions
Radiated Emissions
Harmonics
Voltage Fluctuation and Flicker
Electrostatic Discharge
Radiated Immunity
Electrical Fast Transient/Burst, Power Leads
Electrical Fast Transient/Burst, I/O Leads
Surge Immunity, Power Leads
Conducted Immunity, Power Leads
Conducted Immunity, I/O Leads
Voltage Dips, Interrupts and Variations

übereinstimmt und damit den Bedingungen entspricht.
and therefore corresponds to the regulations of the directive.
et répond ainsi aux dispositions de la directive.

Dachau, 27. Februar 2012

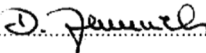
.....

Ort und Datum der Ausstellung
Place and date of issue
Lieu et date d'établissement

Name und Unterschrift des Befugten
Name and signature of authorized person
Nom et signature de la personne autorisée

Chapter 8 Regulatory

As required by the WEEE (Waste Electrical and Electronic Equipment Directive) of the European Community and the corresponding national laws, Thorlabs offers all end users in the EC the possibility to return “end of life” units without incurring disposal charges.

- This offer is valid for Thorlabs electrical and electronic equipment:
- Sold after August 13, 2005
- Marked correspondingly with the crossed out “wheelie bin” logo (see right)
- Sold to a company or institute within the EC
- Currently owned by a company or institute within the EC
- Still complete, not disassembled and not contaminated



Wheelie Bin Logo

As the WEEE directive applies to self contained operational electrical and electronic products, this end of life take back service does not refer to other Thorlabs products, such as:

- Pure OEM products, that means assemblies to be built into a unit by the user (e.g. OEM laser driver cards)
- Components
- Mechanics and optics
- Left over parts of units disassembled by the user (PCB's, housings etc.).

If you wish to return a Thorlabs unit for waste recovery, please contact Thorlabs or your nearest dealer for further information.

8.1. Waste Treatment is Your Own Responsibility

If you do not return an “end of life” unit to Thorlabs, you must hand it to a company specialized in waste recovery. Do not dispose of the unit in a litter bin or at a public waste disposal site.

8.2. Ecological Background

It is well known that WEEE pollutes the environment by releasing toxic products during decomposition. The aim of the European RoHS directive is to reduce the content of toxic substances in electronic products in the future.

The intent of the WEEE directive is to enforce the recycling of WEEE. A controlled recycling of end of life products will thereby avoid negative impacts on the environment.

Chapter 9 Thorlabs Worldwide Contacts

USA, Canada, and South America

Thorlabs, Inc.
56 Sparta Avenue
Newton, NJ 07860
USA
Tel: 973-300-3000
Fax: 973-300-3600
www.thorlabs.com
www.thorlabs.us (West Coast)
Email: sales@thorlabs.com
Support: techsupport@thorlabs.com

Europe

Thorlabs GmbH
Hans-Böckler-Str. 6
85221 Dachau
Germany
Tel: +49-(0)8131-5956-0
Fax: +49-(0)8131-5956-99
www.thorlabs.de
Email: europe@thorlabs.com

France

Thorlabs SAS
109, rue des Côtes
78600 Maisons-Laffitte
France
Tel: +33 (0) 970 444 844
Fax: +33 (0) 825 744 800
www.thorlabs.com
Email: sales.fr@thorlabs.com

Japan

Thorlabs Japan, Inc.
Higashi-Ikebukuro Q Building 1F
2-23-2, Higashi-Ikebukuro,
Toshima-ku, Tokyo 170-0013
Japan
Tel: +81-3-5979-8889
Fax: +81-3-5979-7285
www.thorlabs.jp
Email: sales@thorlabs.jp

UK and Ireland

Thorlabs Ltd.
1 Saint Thomas Place, Ely
Cambridgeshire CB7 4EX
Great Britain
Tel: +44 (0)1353-654440
Fax: +44 (0)1353-654444
www.thorlabs.com
Email: sales.uk@thorlabs.com
Support: techsupport.uk@thorlabs.com

Scandinavia

Thorlabs Sweden AB
Mölnåldalsvägen 3
412 63 Göteborg
Sweden
Tel: +46-31-733-30-00
Fax: +46-31-703-40-45
www.thorlabs.com
Email: scandinavia@thorlabs.com

China

Thorlabs China
Room A101, No. 100
Lane 2891, South Qilianshan Road
Putuo District
Shanghai
China
Tel: +86 (0) 21-60561122
Fax: +86 (0)21-32513480
www.thorlabs.hk
Email: chinasales@thorlabs.com



THORLABS
www.thorlabs.com
